

THIS BOOK

BELONGS TO:

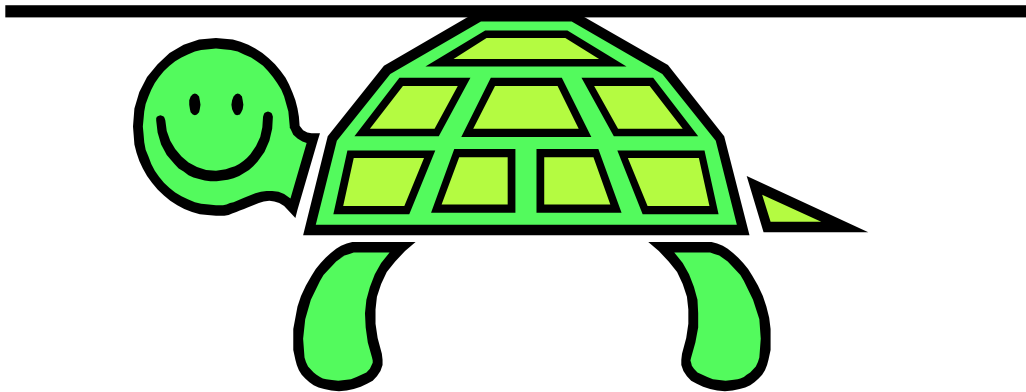

When I go to court

WHERE
DO I
GO..?

MOVIE
THEATRE

THE
MALL

PLAYGROUND



GROCERY
STORE

ZOO

COURTHOUSE

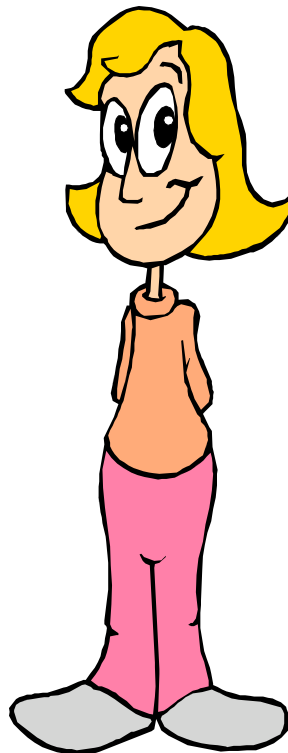

SCHOOL

CIRCLE THE ANSWERS YOU THINK ARE RIGHT

STATE OF MICHIGAN
County of Kent ss.

The People of the State of Michigan
V
John Doe

Charge: Assault

To: Ruth Stephen
82 Ionia
Grand Rapids, MI

CC No. _____
Exam Date _____
Date: March 9, 2002
Time: 8:30 am

SUBPOENA

IN THE CIRCUIT COURT
FOR THE COUNTY OF KENT
Hall of Justice, 333 Monroe Ave., N.W.
Grand Rapids, Michigan

PLEASE CALL ~~336-3241~~ AFTER 5:30 P.M.
THE DAY BEFORE YOUR CASE IS SET
FOR TRIAL TO DETERMINE WHETHER
YOU MUST APPEAR IN COURT

THANK YOU FOR YOUR CO-OPERATION

Will C. Fugitt
Kent County Prosecutor

WITNESS INSTRUCTIONS: Please report at
the victim witness/services located in
"Room 200", Hall of Justice, on the date and
time shown.



YOU ARE HEREBY COMMANDED to appear personally before the Circuit Court
for the County of Kent at the Hall of Justice in the City of Grand Rapids at the date and
time above stated, then and there to give evidence in the above entitled cause, on the
part of the People.
HEREIN FAIL NOT ON PAIN OF THE PENALTY THAT WILL FALL THEREON.

Issued at Grand Rapids, Michigan, on: February 23, 2001

By: Terri L. Land, County Clerk

Social Security Number _____ Round Trip Mileage _____ Payee _____ Witness Fee _____
Payment Description _____

Approval for Payment: _____ Date: _____

31	INVOICE	46	47	ACCOUNT DISTRIBUTION				60	79	80
NUMBER	DATE	FUND	FUNC	ACTIVITY	ACCOUNT	NET AMOUNT	79	80		
USE SOC. SEC. NO.							REC	EXP		
FOR INDIVIDUAL PYMTS										
TOTAL AMOUNT PAYABLE										

This space for controller office use only

Checked by _____

Form # 156 Macro 57 (Rev. 3/00)

What Day

What Time

Please Call

Where You Go

Your name
will be here

Before you have to come to court
you will get a paper like this one. It is called a
subpoena. It will have your name on it and will
tell you

- where you have to go
- what day you have to go
- what time you have to go

Be sure to bring this paper with you when you
come to court.

The detective you talked to will also get a subpoena for court and will meet you there.



My Detective's Name Is:

Courtroom

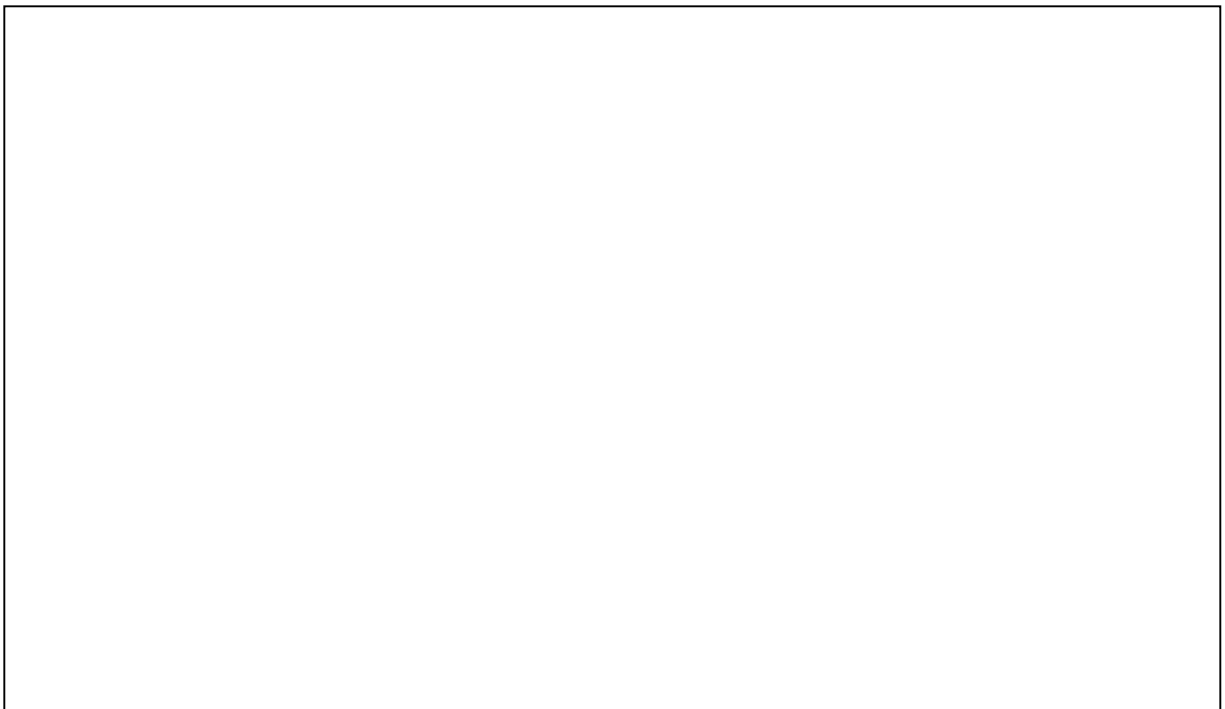

Draw a picture of your courtroom.

When I go to court

WHO WILL I MEET...?

POLICE
OFFICER

DOCTOR

BUS DRIVER

TEACHER



JUDGE

ELEPHANT

ATTORNEY

FRIEND

MAILMAN

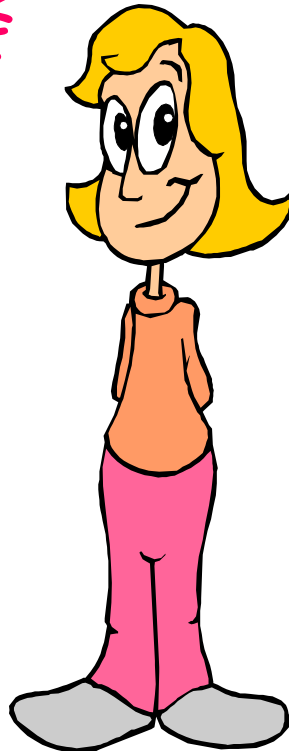

CIRCLE THE ANSWERS YOU THINK ARE RIGHT

Court Reporter



The Court Reporter writes down everything that is said in the courtroom

Bailiff



Makes sure the courtroom rules are obeyed.

Guard



A police officer who helps keep the courtroom a safe place.

Witness

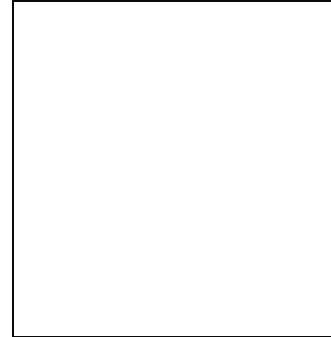

Draw yourself here



A person who saw the crime happen or who knows something about the crime.

Defense Attorney



The lawyer who helps the person accused of breaking the law. He or she asks the witness questions in court.

Defendant



The person accused of breaking the law.

When I go to court

WHAT
DO I
DO?

EAT

THINK

WATCH



SING



LISTEN

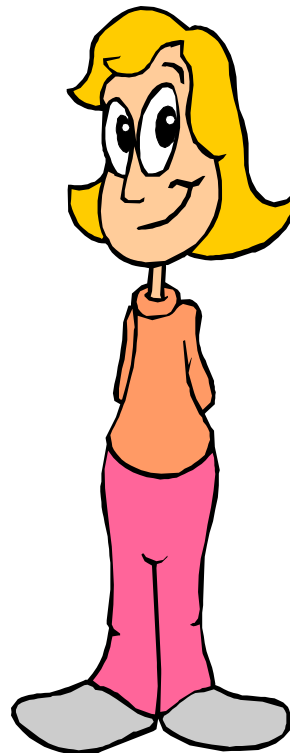

TALK

DANCE

PLAY

BE QUIET

RUN

CIRCLE THE ANSWERS YOU THINK ARE RIGHT

Tell What Really Happened



The truth is what happened. It is right. It is good to tell the truth.

A lie is something that did not happen. It is wrong. It is not good to tell a lie.

This is an airplane.

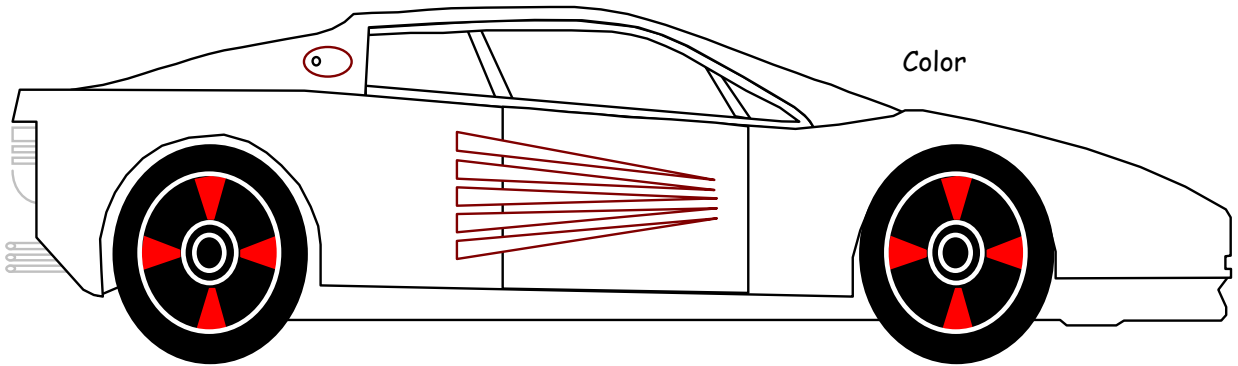

Right

or

Wrong?

Start

Maze

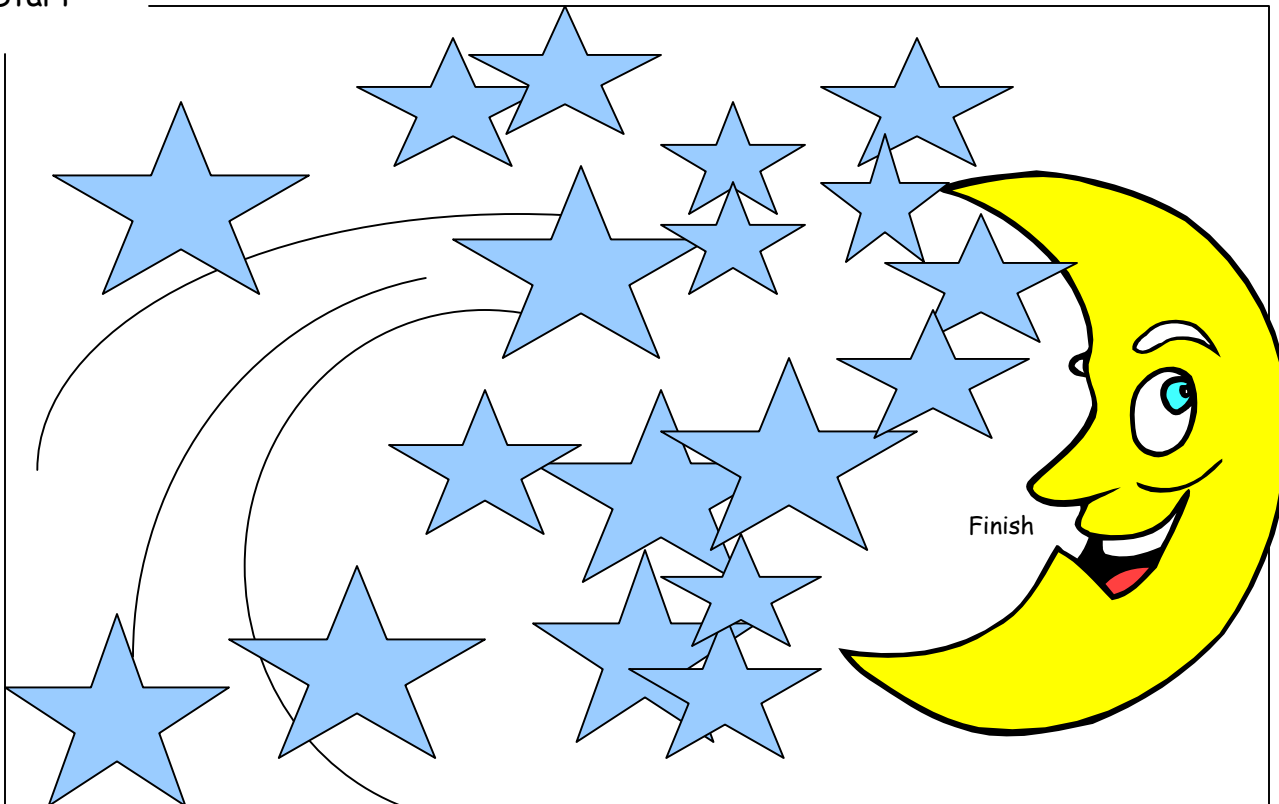

When the stars & moon are out - it is nighttime.

Truth

or

Lie?

First: You will meet with your advocate.

Second: You will meet the prosecutor who will ask you what happened... Tell the truth.



Draw a picture of you with your Prosecutor

Then:

You will go into the courtroom and the judge will ask you to promise to tell the truth.

The prosecutor will ask you questions.

The defense attorney will ask you questions.

The judge may also ask you some questions.

Tell all of them the truth.

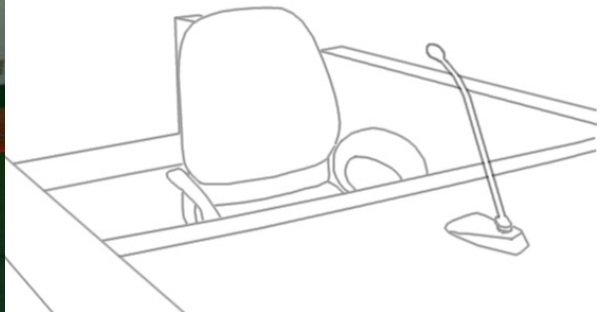

Draw a picture of yourself on the Witness Chair

Later on, you may have to come back to court to tell a jury what happened.



The jury hears all the witnesses and then decides if the defendant is guilty or not guilty.

Remember:

If you ever have a question or something has you worried, call your victim advocate.

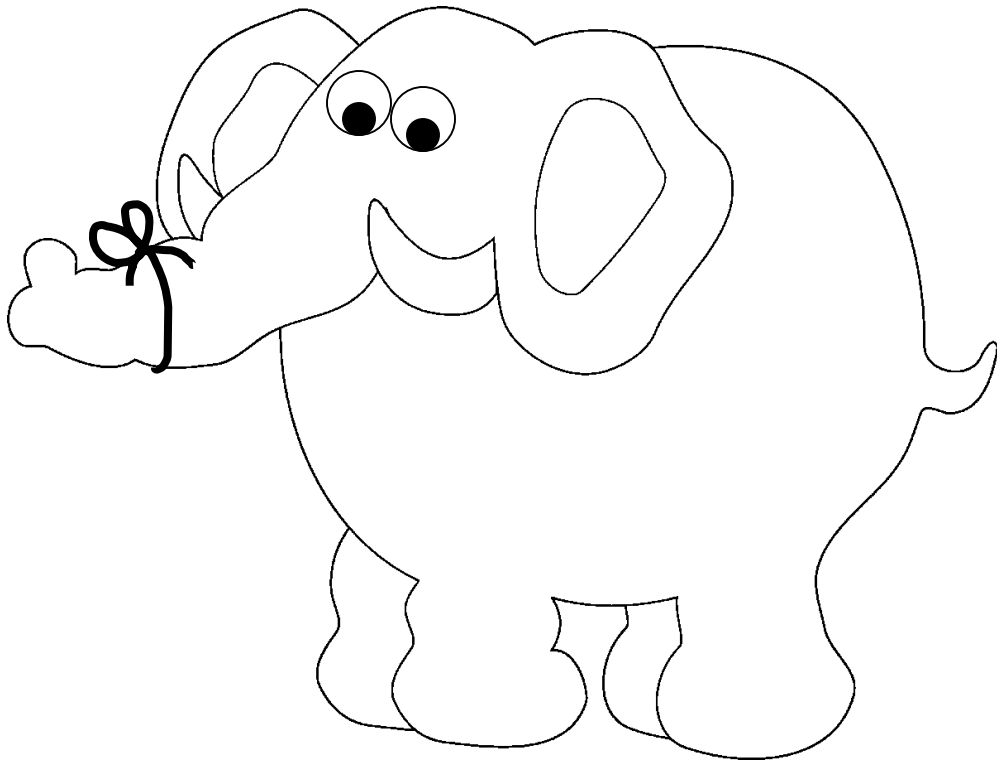

You will not see one of these in the courtroom

Name: _____

Phone: _____

Match the Word with the Right Sentence



Judge	The person who tells the victim and the witnesses about court and answers questions. You can tell this person if you are afraid or worried.
Jury	The person who tries to show a judge or jury that the defendant broke the law.
Witness	The person accused of breaking the law.
Sentence	A person who saw the crime happen or knows about the crime.
Defendant	In court, the person who helps the defendant.
Victim Advocate	The person who sits in the highest chair in the courtroom and wears a black robe.
Prosecutor or Prosecuting Attorney	The people who hear all the witnesses and then decide if the defendant is guilty or not guilty.
Defense Attorney Or Defendant's Attorney	The punishment or special help the Judge says the defendant will get.